

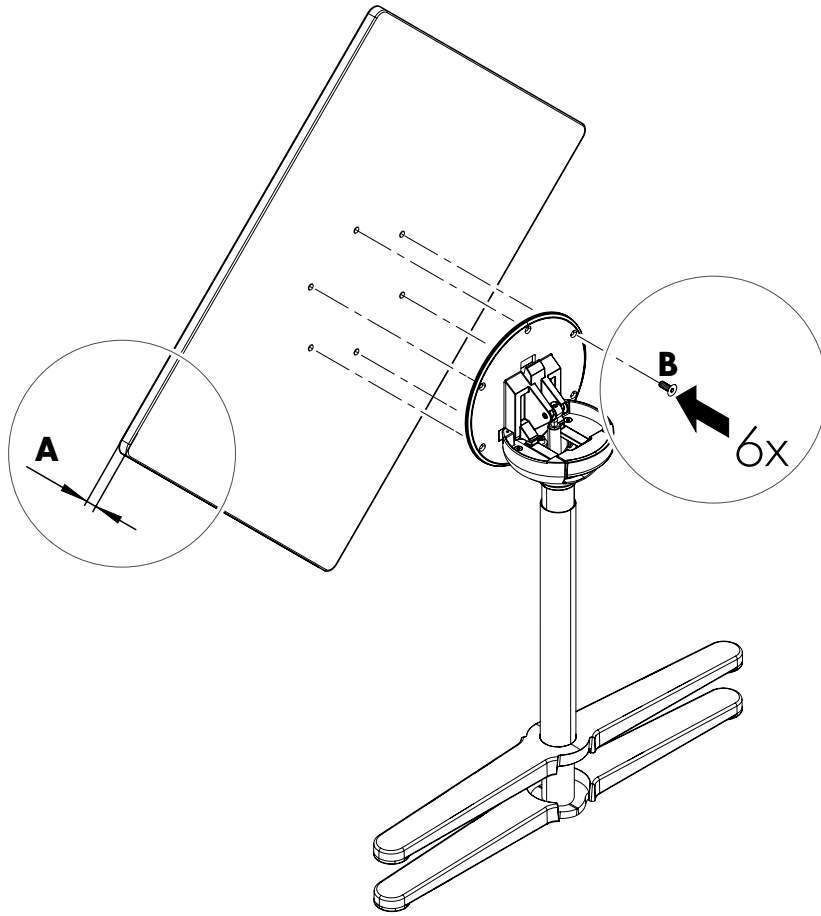

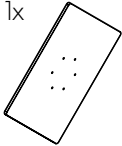

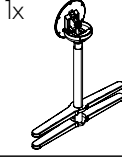

Super Fold Table

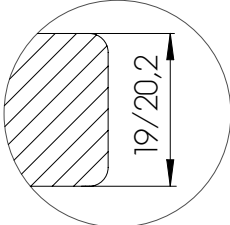

- 1x 
- 1x 
- 6x
M6x20

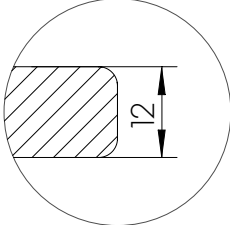
- 6x
T6x16

A	B
	<p>M6x20 </p> <p> = SW4 + 7 Nm</p>
	<p>T6x16 </p> <p> = T30 + 5 Nm</p>