

# LINEAR SYSTEM SERIES—ORDER GUIDE

The Linear System Series brings a new perspective to the evolving needs of the modern workspaces, hospitality settings and educational institutions through its configurable design across tables, lighting, screens and trays alongside its custom integrated power solution, allowing one to tailor the design to the exact needs of any space.

**Option A** — Choose between one of our predesigned table configurations and simply add your desired lamps and accessories.

**Option B** — Create your own configuration from scratch and add lamps and accessories from there. [Scroll down 6 pages.](#)

## Option A — Predesigned Table Configurations

### STEP 1. TABLES

Select either the Linear System Table or one of three Linear System Table Configurations.

**Note**  
Different finishes of tabletops cannot be mixed as they might vary in thickness.

#### Linear System Table

Height — 74 cm / 29.1"  
Table top width — 142 cm / 55.9"  
Total width — 146.9 cm / 57.8"  
Total length — 240 cm / 94.5"  
No of Persons — 4-6

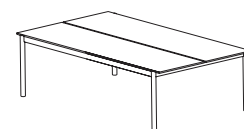

240 cm / 94.5"

#### Linear System Table Configuration 1

Height — 74 cm / 29.1"  
Table top width — 142 cm / 55.9"  
Total width — 146.9 cm / 57.8"  
Total length — 360 cm / 141.7"  
No of Persons — 6-8

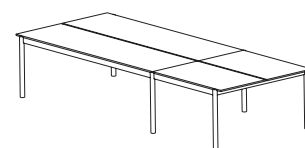

240 cm / 94.5"    120 cm / 47.2"

#### Linear System Table Configuration 2

Height — 74 cm / 29.1"  
Table top width — 142 cm / 55.9"  
Total width — 146.9 cm / 57.8"  
Total length — 480 cm / 189"  
No of Persons — 8-12

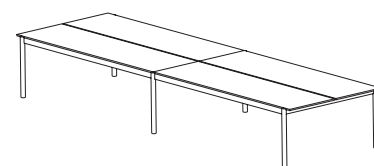

240 cm / 94.5"    240 cm / 94.5"

#### Linear System Table Configuration 3

Height — 74 cm / 29.1"  
Table top width — 142 cm / 55.9"  
Total width — 146.9 cm / 57.8"  
Total length — 720 cm / 283.5"  
No of Persons — 12-18

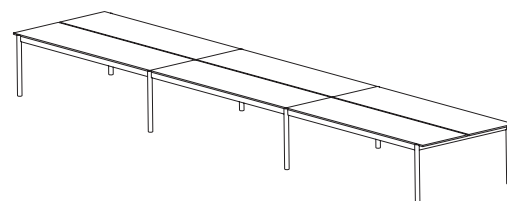

240 cm / 94.5"    240 cm / 94.5"    240 cm / 94.5"

### OPTION A

[1. TABLES](#) / [2. ACCESSORIES](#) / [3. LIGHTING](#) / [4. TABLE POWER OUTLET](#) / [5. INTEGRATED POWER](#) / [6. CABLE TRAY](#)

# LINEAR SYSTEM SERIES—ORDER GUIDE

## STEP 2. ACCESSORIES

### Trays

Add your desired number of Linear System Trays.

#### Note

Trays must be mounted at least 5 cm / 2" from the table edge.

### Linear System Tray — Ø24 cm / 9.5"

Height — 15,6 cm / 6.2"  
Diameter — 24 cm / 9.5"



### Linear System Tray — Ø36 cm / 14.2"

Height — 9,6 cm / 3.8"  
Diameter — 36 cm / 14.2"



### Linear System Tray — 170 cm / 66.9"

Height — 15 cm / 5.9"  
Width — 21 cm / 8.3"  
Length — 170 cm / 66.9"

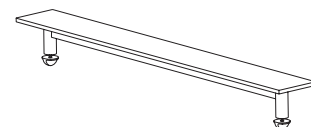

### Screens

Add your desired number of Linear System Screens.

#### Note

We recommend that screens are mounted to the table. They must be placed at least 5 cm / 2" from the table edge.

### Linear System Screen — 75 cm / 29.5"

Height — 35 cm / 13.8"  
Width — 15 cm / 5.9"  
Length — 75 cm / 29.5"

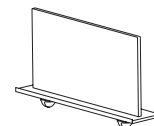

### Linear System Screen — 125 cm / 49.2"

Height — 35 cm / 13.8"  
Width — 15 cm / 5.9"  
Length — 125 cm / 49.2"

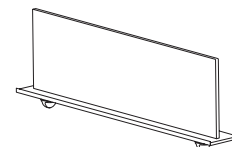

### Linear System Screen — 178 cm / 70.1"

Height — 35 cm / 13.8"  
Width — 15 cm / 5.9"  
Length — 178 cm / 70.1"

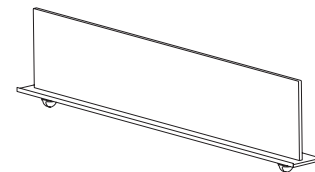

#### Note

Please note that only the Linear System Screen 125 cm / 49.2" can be mounted across the table.

### Example

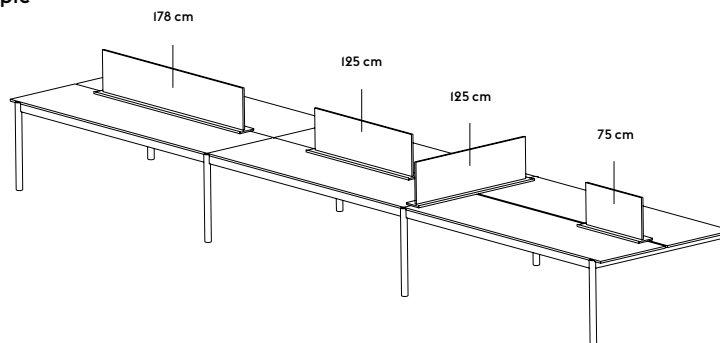

#### OPTION A

1. TABLES / 2. ACCESSORIES / 3. LIGHTING / 4. TABLE POWER OUTLET / 5. INTEGRATED POWER / 6. CABLE TRAY

# LINEAR SYSTEM SERIES—ORDER GUIDE

## STEP 3. LIGHTING

Add your desired number of Linear Lamps.

**Note**  
The Linear Table Lamp has one USB-C plug.

### Linear Table Lamp

Height — 36,5 cm / 14.4"  
Width — 23,2 cm / 9.1"  
Depth — 16,5 cm / 6.5"



**Note**  
Linear Mounted Lamp must be mounted at least 5 cm / 2" from the table edge.

Please be aware that the Linear Mounted Lamp and Table Power Outlet, both designed for the Linear System Series, have a special power solution with special plugs. See more on page 4

### Linear Mounted Lamp — 23,2 cm / 9.1"

Height — 36,5 cm / 14.4"  
Width — 23,2 cm / 9.1"  
Depth — 10,7 cm / 4.2"

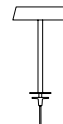

### Linear Mounted Lamp — 209,2 cm / 82.4"

Height — 70,7 cm / 27.8"  
Width — 209,2 cm / 82.4"  
Depth — 10,7 cm / 4.2"



### Linear Pendant Lamp — 87,2 cm / 34.3"

Height — 5,4 cm / 2.1"  
Width — 87,2 cm / 34.3"  
Depth — 10,7 cm / 4.2"



### Linear Pendant Lamp — 169,2 cm / 66.6"

Height — 5,4 cm / 2.1"  
Width — 169,2 cm / 66.6"  
Depth — 10,7 cm / 4.2"



## STEP 4. TABLE POWER OUTLETS

Specify your desired number of Table Power Outlets. Each Table Power Outlet has two outlets (one at each end) and one USB-A and USB-C plug to which standard plugs can be connected. Kindly remember to select your region-specific version.

**Note**  
Linear System Table Power Outlet must be mounted at least 5 cm / 2" from the table edge.

### Linear System Table Power Outlet — EU, UK

Height — 7 cm / 2.8"  
Width — 7 cm / 2.8"  
Length — 18 cm / 7.1"

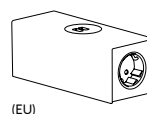

(EU)

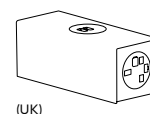

(UK)

### OPTION A

1. TABLES / 2. ACCESSORIES / 3. LIGHTING / 4. TABLE POWER OUTLET / 5. INTEGRATED POWER / 6. CABLE TRAY

PRICE LIST  
FOR MORE INFORMATION, VISIT MUUTO.COM

**MUUTO**

# LINEAR SYSTEM SERIES—ORDER GUIDE

## STEP 5. INTEGRATED POWER FOR MOUNTED LAMPS & TABLE POWER OUTLETS

If you'd like to add the Mounted Lamp(s) or Table Power Outlet(s), select the Table Power Kit for the Linear System Table or one of the three Power Configurations that match your selected Linear System Table Configuration. Kindly remember to select the region-specific power kit.

**Note**  
Each Distribution Block has five outlets to which up to five Linear Mounted Lamps or Linear System Table Power Outlets can be plugged in.

The Extension Kit must be connected to the Power Kit. An Extension Kit has no standard plug.

Distribution Block — 5-way

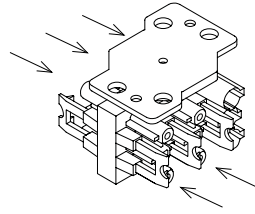

EU cable  
1,5 M cable

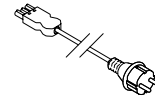

UK cable  
1,5 M fused plug

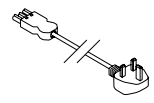

### Linear System Table

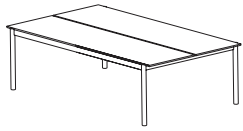

### Linear System Power

Power Kit (1 pcs)  
150 cm / 59" cable (EU or UK)  
Distribution Block

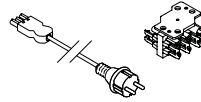

### Linear System Table Configuration 1

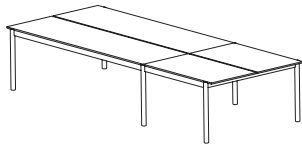

### Linear System Power Configuration 1

Power Kit (1 pcs)  
150 cm / 59" cable (EU or UK)  
Distribution Block

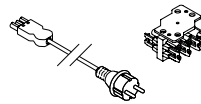

Power Extension Kit — 200 cm (1 pcs)  
200 cm / 79" cable  
Distribution Block

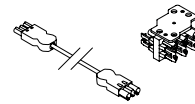

+

### Linear System Table Configuration 2

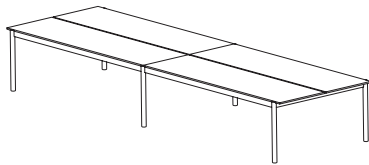

### Linear System Power Configuration 2

Power Kit (1 pcs)  
150 cm / 59" cable (EU or UK)  
Distribution Block

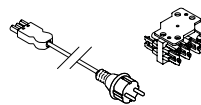

Power Extension Kit — 250 cm (1 pcs)  
250 cm / 98" cable  
Distribution Block

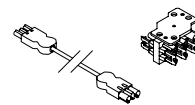

+

### Linear System Table Configuration 3

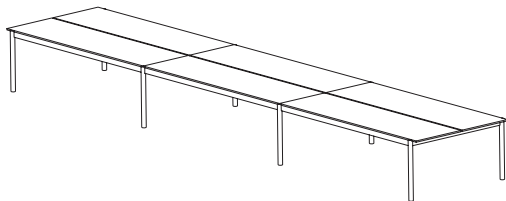

### Linear System Power Configuration 3

Power Kit (1 pcs)  
150 cm / 59" cable (EU or UK)  
Distribution Block

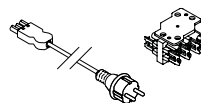

Power Extension Kit — 250 cm (2 pcs)  
250 cm / 98" cable  
Distribution Block

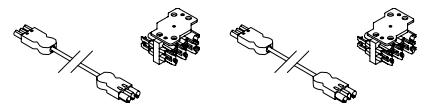

+

### OPTION A

1. TABLES / 2. ACCESSORIES / 3. LIGHTING / 4. TABLE POWER OUTLET / 5. INTEGRATED POWER / 6. CABLE TRAY

PRICE LIST  
FOR MORE INFORMATION, VISIT MUUTO.COM

**MUUTO**

# LINEAR SYSTEM SERIES—ORDER GUIDE

**Note**

The Integrated Power for Linear System Series has unique internal plugs to provide a slim and discreet look. This means that you cannot connect a standard plug to the power without using the Linear Table Power Outlet or changing the standard plug to a matching plug, being the Wieland GSTI8I3 plug.

The Linear Mounted Lamps must be connected to the integrated Power Kit.

Wieland GSTI8I3 plug

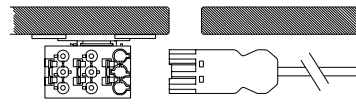

Standard plug (EU or UK)

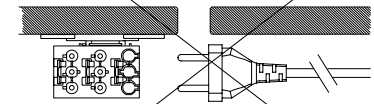

1. Connecting using the Wieland GSTI8I3 plug

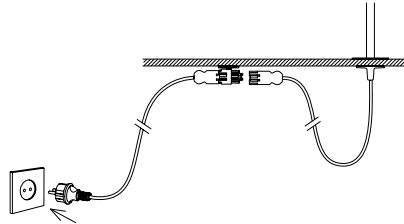

2. Connecting using a standard plug to the Linear Table Power Outlet

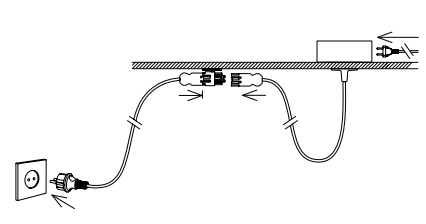

## LINEAR TABLE LAMP ONLY

The Linear Table Lamp can either be connected to a standard wall plug or the Table Power Outlet.

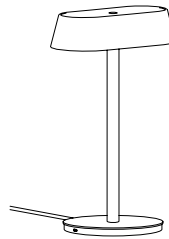

Standard plug

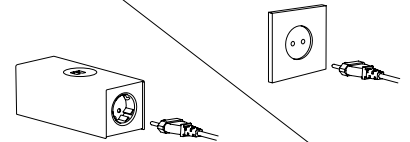

Linear Table Power Outlet

Alternatively, you can connect it to the integrated Power Kit by replacing the plug with a custom Wieland GSTI8I3 plug that is included with the lamp. Kindly refer to the Linear Table Lamp manual for instructions.

Integrated Power Kit (Wieland GSTI8I3 plug)

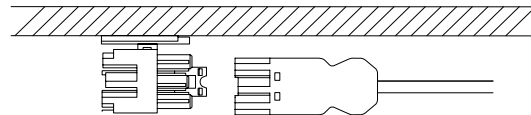

OPTION A

1. TABLES / 2. ACCESSORIES / 3. LIGHTING / 4. TABLE POWER OUTLET / 5. INTEGRATED POWER / 6. CABLE TRAY

# LINEAR SYSTEM SERIES—ORDER GUIDE

---

## STEP 6. CABLE TRAYS

We recommend using 1 Cable Tray for the End Module – 120 cm / 47.2" and up to 3 Cable Trays for the Linear Table, End Module – 240 cm / 94.2" and the Middle Module – 240 cm / 94.2".

### Linear System Cable Tray

Height – 3 cm / 1.2"  
Width – 22 cm / 8.7"  
Depth – 60 cm / 23.7"

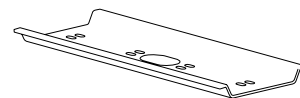

---

### Example:

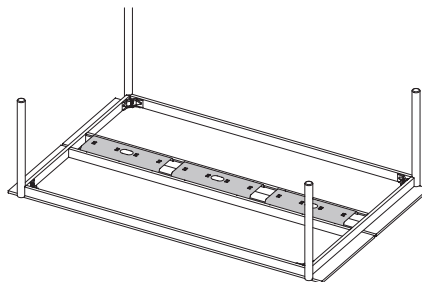

Linear System Table – 240 cm / 94.5"

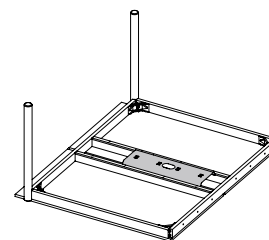

Linear System End Module – 120 cm / 47.2"

---

### OPTION A

1. TABLES / 2. ACCESSORIES / 3. LIGHTING / 4. TABLE POWER OUTLET / 5. INTEGRATED POWER / 6. CABLE TRAY

PRICE LIST  
FOR MORE INFORMATION, VISIT MUUTO.COM

**MUUTO**

# LINEAR SYSTEM SERIES—ORDER GUIDE

## Option B — Create your own configuration

### STEP 1. TABLES

#### A)

A configuration must always have End Modules in each end.

Start by defining the total length of your desired configuration, then select two table ends.

**Note**  
Different finishes of tabletops cannot be mixed as they might vary in thickness.

#### Linear System End Module — 240 cm / 94.5"

Height — 74 cm / 29.1"  
Width — 146,9 cm / 57.8"  
Length — 240 cm / 94.5"  
No of Persons — 4-6



#### Linear System End Module — 120 cm / 47.2"

Height — 74 cm / 29.1"  
Width — 146,9 cm / 57.8"  
Length — 120 cm / 47.2"  
No of Persons — 2



#### B)

Next, add the second, and final, End Module or your desired number of Middle Modules, only available in 240 cm / 94.5".

**Note**  
Please note that it is not possible to connect more than two End Modules.

#### Linear System Middle Module — 240 cm / 94.5"

Width — 146,9 cm / 57.8"  
Length — 240 cm / 94.5"  
No of Persons — 4-6



#### C)

Next, you must order 1 set of Connecting Legs every time two modules are connected.

#### Linear System Connecting Legs

Height — 74 cm / 29.1"

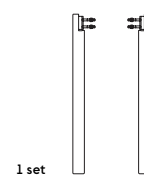

If you'd like a configuration of one End Module — 240 cm / 94.5" and one Middle Module — 240 cm / 94.5" and one End Module — 240 cm / 94.5", you must order two sets of Connecting Legs, as shown in the illustration.

#### Example

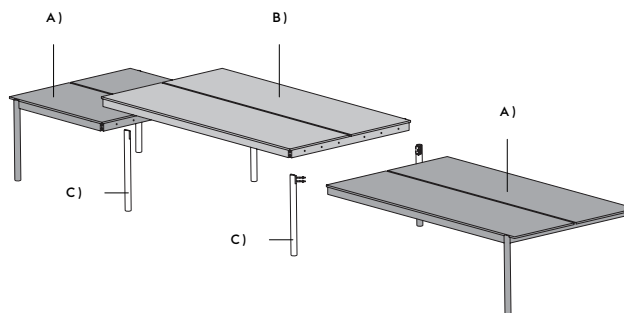

### OPTION B

1. TABLES / 2. ACCESSORIES / 3. LIGHTING / 4. TABLE POWER OUTLET / 5. INTEGRATED POWER / 6. CABLE TRAY

# LINEAR SYSTEM SERIES—ORDER GUIDE

## STEP 2. ACCESSORIES

### Trays

Add your desired number of Linear System Trays.

**Note**  
Trays must be mounted at least 5 cm / 2" from the table edge.

### Linear System Tray — Ø24 cm / 9.5"

Height — 15,6 cm / 6.2"  
Diameter — 24 cm / 9.5"



### Linear System Tray — Ø36 cm / 14.2"

Height — 9,6 cm / 3.8"  
Diameter — 36 cm / 14.2"



### Linear System Tray — 170 cm / 66.9"

Height — 15 cm / 5.9"  
Width — 21 cm / 8.3"  
Length — 170 cm / 66.9"

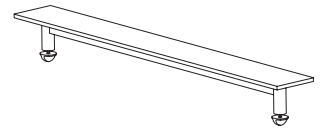

### Screens

Add your desired number of Linear System Screens.

**Note**  
We recommend that screens are mounted to the table. They must be placed at least 5 cm / 2" from the table edge.

### Linear System Screen — 75 cm / 29.5"

Height — 35 cm / 13.8"  
Width — 15 cm / 5.9"  
Length — 75 cm / 29.5"

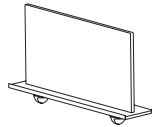

### Linear System Screen — 125 cm / 49.2"

Height — 35 cm / 13.8"  
Width — 15 cm / 5.9"  
Length — 125 cm / 49.2"

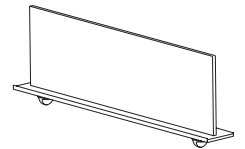

### Linear System Screen — 178 cm / 70.1"

Height — 35 cm / 13.8"  
Width — 15 cm / 5.9"  
Length — 178 cm / 70.1"

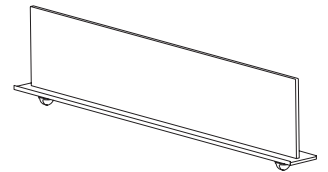

**Note**  
Please note that only the Linear System Screen 125 cm / 49.2" can be mounted across the table.

### Example

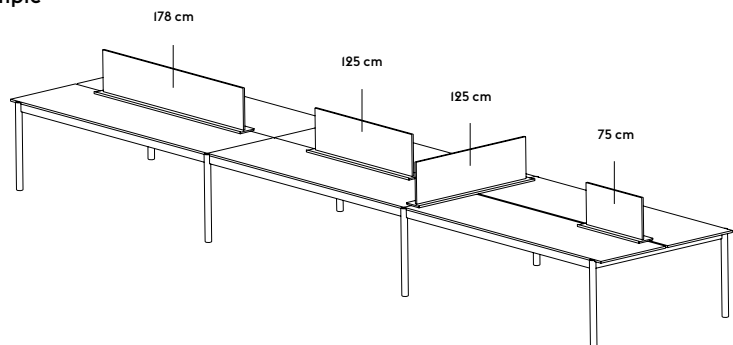

### OPTION B

1. TABLES / 2. ACCESSORIES / 3. LIGHTING / 4. TABLE POWER OUTLET / 5. INTEGRATED POWER / 6. CABLE TRAY

PRICE LIST  
FOR MORE INFORMATION, VISIT MUUTO.COM

**MUUTO**



# LINEAR SYSTEM SERIES—ORDER GUIDE

## STEP 3. LIGHTING

Add your desired number of Linear Lamps.

### Note

The Linear Table Lamp has one USB-C plug.

### Linear Table Lamp

Height — 36,5 cm / 14.4"  
Width — 23,2 cm / 9.1"  
Depth — 16,5 cm / 6.5"



### Note

Linear Mounted Lamp must be mounted at least 5 cm / 2" from the table edge.

Please be aware that the Linear Mounted Lamp and Table Power Outlet, both designed for the Linear System Series, have a special power solution with special plugs. See more on page 4.

### Linear Mounted Lamp — 23,2 cm / 9.1"

Height — 36,5 cm / 14.4"  
Width — 23,2 cm / 9.1"  
Depth — 10,7 cm / 4.2"

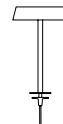

### Linear Mounted Lamp — 209,2 cm / 82.4"

Height — 70,7 cm / 27.8"  
Width — 209,2 cm / 82.4"  
Depth — 10,7 cm / 4.2"



### Linear Pendant Lamp — 87,2 cm / 34.3"

Height — 5,4 cm / 2.1"  
Width — 87,2 cm / 34.3"  
Depth — 10,7 cm / 4.2"



### Linear Pendant Lamp — 169,2 cm / 66.6"

Height — 5,4 cm / 2.1"  
Width — 169,2 cm / 66.6"  
Depth — 10,7 cm / 4.2"



## STEP 4. TABLE POWER OUTLETS

Specify your desired number of Table Power Outlets. Each Table Power Outlet has two outlets (one at each end) and one USB-A and USB-C plug to which standard plugs can be connected. Kindly remember to select your region-specific version.

### Note

Linear System Table Power Outlet must be mounted at least 5 cm / 2" from the table edge.

### Linear System Table Power Outlet — EU, UK

Height — 7 cm / 2.8"  
Width — 7 cm / 2.8"  
Length — 18 cm / 7.1"

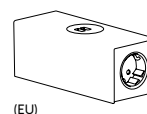

(EU)

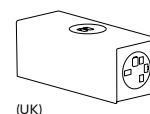

(UK)

## OPTION B

1. TABLES / 2. ACCESSORIES / 3. LIGHTING / 4. TABLE POWER OUTLET / 5. INTEGRATED POWER / 6. CABLE TRAY

# LINEAR SYSTEM SERIES—ORDER GUIDE

## STEP 5. INTEGRATED POWER FOR MOUNTED LAMPS & TABLE POWER OUTLET

If you'd like to add the Mounted Lamp(s) and/or Table Power Outlet(s), select the Power Kit for the first End Module you choose and then add an a Power Extension Kit for each table added.

### Power Kit (1 pcs)

150 cm / 59" cable (EU or UK)  
Distribution Block

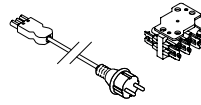

### Power Extension Kit (X pcs)

200 cm / 79" or 250 cm / 98" cable  
Distribution Block

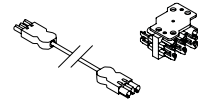

If you add a End Module or a Middle Module — 240 cm / 94.5", select the 250 cm / 98" Power Extension Kit.

If you add a End Module — 120 cm / 47.2", select the 200 cm / 79" Power Extension kit.

### Example 1

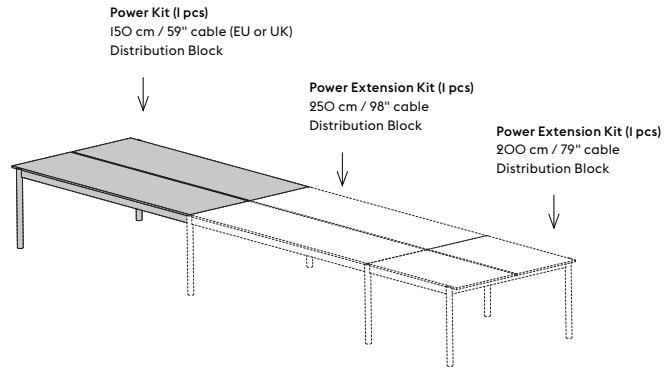

### Example 2

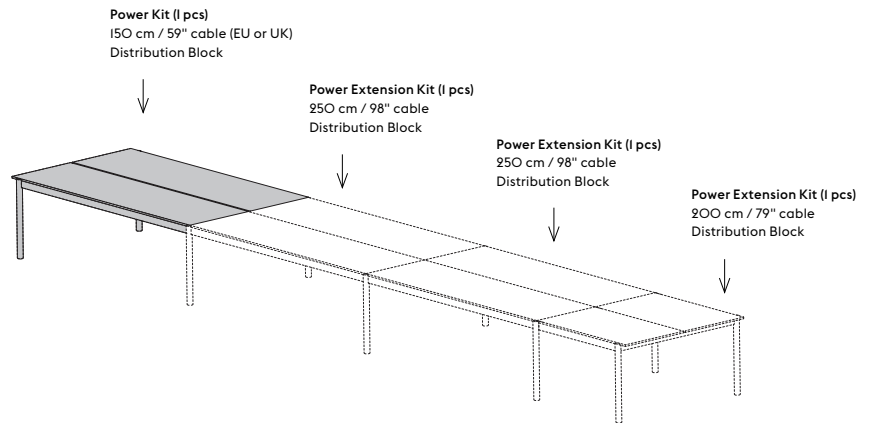

## OPTION B

1. TABLES / 2. ACCESSORIES / 3. LIGHTING / 4. TABLE POWER OUTLET / 5. INTEGRATED POWER / 6. CABLE TRAY

# LINEAR SYSTEM SERIES—ORDER GUIDE

## LINEAR TABLE LAMP ONLY

The Linear Table Lamp can either be connected to a standard wall plug or the Table Power Outlet.

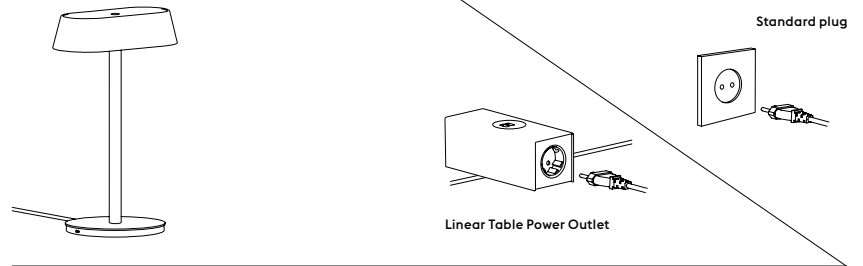

Alternatively, you can connect it to the integrated Table Power Kit by replacing the plug with a custom Wieland GST1813 plug that is included with the lamp. Kindly refer to the Linear Table Lamp manual for instructions.

Integrated Table Power Kit (Wieland GST1813 plug)

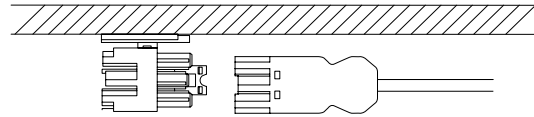

## STEP 6. CABLE TRAYS

We recommend using 1 Cable Tray for the End Module – 120 cm / 47.2" and up to 3 Cable Trays for the Linear Table, End Module – 240 cm / 94.2" and the Middle Module – 240 cm / 94.2".

### Linear System Cable Tray

Height – 3 cm / 1.2"  
Width – 22 cm / 8.7"  
Depth – 60 cm / 23.7"

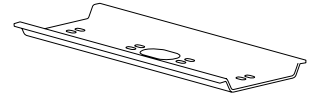

### Example:

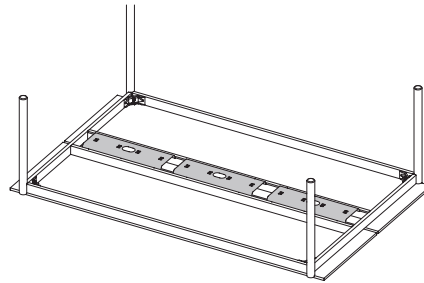

Linear System Table – 240 cm / 94.5"

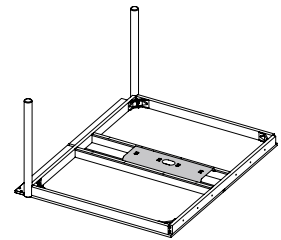

Linear System End Module – 120 cm / 47.2"

## OPTION B

1. TABLES / 2. ACCESSORIES / 3. LIGHTING / 4. TABLE POWER OUTLET / 5. INTEGRATED POWER / 6. CABLE TRAY

PRICE LIST  
FOR MORE INFORMATION, VISIT MUUTO.COM

**MUUTO**

