

# Linear System Table

“The Linear System Series places people at its center, being a place to meet, to collaborate or to work in focused solitude. The design process was about creating a system that made for intimately welcoming atmospheres, enhanced by the expression and functionality of its lighting and accessories. With its warm materiality and modern expression, the Linear System Series brings feelings of home into larger spaces to give the user a sense of belonging, even if being there only for a little while. The extensive selection of lighting and accessories means that the Linear System Series can be configured and reshuffled for any purpose of the modern workplace as well as hospitality settings and public areas, arraying the ideas of aesthetic and function into one.”

— Thomas Bentzen



<b>Designed by</b>	Thomas Bentzen
<b>About the Designer</b>	Thomas Bentzen, former Head of Design at Muuto, started his own studio in 2010. Bentzen’s designs are characterized by simplicity, rationality and functionality — always firmly rooted in the Danish design tradition, material knowledge, craftsmanship and rational industrial manufacturing processes. His work continues to receive international recognition at fairs and exhibitions all over the world.
<b>Environment</b>	Indoor
<b>Country of Production</b>	Latvia
<b>Preassembled</b>	No - Full assembly of chosen configuration is needed. Please see more information in the assembly instruction.
<b>Description</b>	The Linear System Table is a simple yet refined table with subtle details and references to the Scandinavian design heritage. Its legs are cut into half-circles and joined with the table for a light appearance, while the slender overhang at both ends of the table makes for a refined expression. The Linear System Table is available as a freestanding table, in predesigned configurations, or as modules that you can use to customize your configuration. The narrow version of the Linear System Table is ideal for conference and meeting rooms.

# Linear System Table

## Material

Tabletop in Oak Veneer, Black version in Ash Veneer or Black Nanolaminate.

Black Nanolaminate has an ABS edge. Multiple tabletop finishes cannot be mixed in a linear system configuration.

The table frame is veneered plywood, and the legs are solid oak. Felt glides included.

Oak Veneer color variations: The Linear System Series oak veneer tabletops use high-quality mix-matched veneer to reduce differences in the visual appearance from tabletop to tabletop. However, wood is a natural material, meaning slight variations can occur from table to table.

Lacquered Oak: Oak is a traditionally Scandinavian material. It is durable against factors such as water and fungi and has a high level of strength, giving it long-lasting properties suitable for furniture.

Nanolaminate: Nanolaminate is a fully dense, ultra-fine-grained solid with a high concentration of interface defects. It is an innovative material with unique features such as low light reflexivity, an extremely matt surface, anti-fingerprints, and anti-bacterial properties. The nanolaminate surface is also resistant to scratches, dry heat, and acid solvents.

ABS: ABS is a common thermoplastic polymer. Within our collection, ABS is used on the edges of tables for an elegant expression with durable character.

Linear System Table W110 cm: Table frame is made from FSC™-certified (FSC-C028824) wood.

## Cleaning & Care

Wood and Veneer Surfaces: Clean the table with a damp cloth. If necessary, only use a mild detergent or washing-up liquid that is not concentrated. Always wipe with a dry cloth afterward. Liquid, grease, etc., should be removed immediately to minimize the risk of stains and marks.

Laminate Surface: Clean the table with a damp cloth. If necessary, use a mild detergent or washing-up liquid, not concentrated. Always wipe with a dry cloth afterward. Liquids, grease, etc., should be removed immediately to minimize the risk of stains and marks.

Nano Laminate: Treat the surface with a melamine sponge available in hardware stores to reduce minor scratches.

## Options

Accessories: Optional Screens and Trays for the Linear System. Screens are available in three sizes to be used either freestanding or mounted. Trays in three different sizes, all to be mounted. We recommend mounting screens to the table. Both trays and screens must be placed at least 5cm / 2" from the table edge. Lighting: More information is available in separate Product Fact Sheets. Table Power Outlet: Each Table Power Outlet has two standard power sockets and both one USB-A and a USB-C socket. Available in region-specific versions for EU and UK. Find more information in separate Product Fact Sheet. Power Kit: Integrated power for Mounted Lamp(s), Table Lamp(s) or Table Power Outlet(s). Available in region-specific versions for EU, UK and US. Wieland Power distribution block (5-way) and Wieland cables. Find more information in separate Product Fact Sheet. Cable Tray: Cable Tray to organize and hide cables under the table. Find more information in separate Product Fact Sheet.

# Linear System Table

## Dimensions

### Configuration 1 - W: 110 cm / 43.3"

Length: 360 cm / 141.7"  
 Height: 74 cm / 29.1"  
 Width: 115 cm / 45.3"

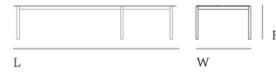

### Configuration 2 - W: 110 cm / 43.3"

Length: 480 cm / 189"  
 Height: 74 cm / 29.1"  
 Width: 115 cm / 45.3"



### Configuration 1 - W: 142 cm / 55.9"

Length: 360 cm / 141.7"  
 Height: 74 cm / 29.1"  
 Width: 147 cm / 57.8"



### Configuration 2 - W: 142 cm / 55.9"

Length: 480 cm / 189"  
 Height: 74 cm / 29.1"  
 Width: 147 cm / 57.8"



### Table - 110 x 240 H: 74 cm / 43.3 x 94.5 H: 29.1"

Length: 240 cm / 94.5"  
 Height: 74 cm / 29.1"  
 Width: 115 cm / 45.3"



### Table - 142 x 240 cm / 55.9 x 94.5"

Length: 240 cm / 94.5"  
 Height: 74 cm / 29.1"  
 Width: 147 cm / 57.8"



## Ready-to-Ship

Black Nanolaminate/Black ABS/Black  
 Black Lacquered Ash Veneer/Black  
 Black Nanolaminate/Black ABS/Oak  
 Oak Veneer/Oak



## Made-to-Order

Please contact our sales team to learn more about made-to-order possibilities.

# Linear System Table

## Tests, Labels & Certifications

### Eco-Labels & Certificates

Forest Stewardship Council™ (FSC-C028824)  
VOC — Bifma X 7.1  
VOC — CDPH 01350

### Safety & Regulations

EAC Certificate  
TSCA Title VI - formaldehyde

### Strength, Durability & Stability

BIFMA X5.5 — Desk Products  
EN 15372-L2 & -L3 Furniture

Linear System Table W110 cm: Table frame is made from FSC™-certified (FSC-C028824) wood. Note that the connector pins in this product contains lead, CAS no. 7439-92-1.

[Explore Assets](#)

[DOWNLOAD SITE](#)

[Create Your Own](#)

[PRODUCT PLANNER](#)

# LINEAR SYSTEM SERIES—ORDER GUIDE

The Linear System Series brings a new perspective to the evolving needs of the modern workspaces, hospitality settings and educational institutions through its configurable design across tables, lighting, screens and trays alongside its custom integrated power solution, allowing one to tailor the design to the exact needs of any space.

**Option A** — Choose between one of our predesigned table configurations and simply add your desired lamps and accessories.

**Option B** — Create your own configuration from scratch and add lamps and accessories from there.

## Option A — Predesigned Table Configurations

### STEP 1. TABLES

Select either the Linear System Table or one of two Linear System Table Configurations.

**Note**  
Different finishes of tabletops cannot be mixed as they might vary in thickness.

**Table**  
No of Persons — 4-6

**Configuration 1**  
No of Persons — 6-8

**Configuration 2**  
No of Persons — 8-12

#### Linear System Table W142

Height — 74 cm / 29.1"  
Table top width — 142 cm / 55.9"  
Total width — 146.9 cm / 57.8"

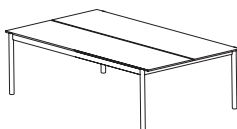

L 240 cm / 94.5"

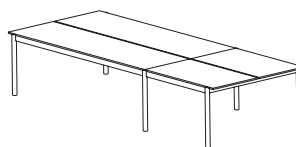

L 360 cm / 141.7"

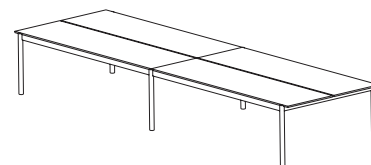

L 480 cm / 189"

#### Linear System Table W110

Height — 74 cm / 29.1"  
Table top width — 110 cm / 43.3"  
Total width — 115 cm / 45.3"

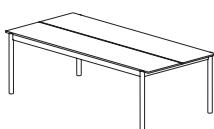

L 240 cm / 94.5"

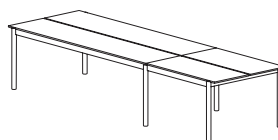

L 360 cm / 141.7"

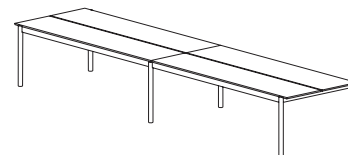

L 480 cm / 189"

#### Linear System Table High H95

Height — 95 cm / 37.4"  
Table top width — 110 cm / 43.3"  
Total width — 115 cm / 45.3"

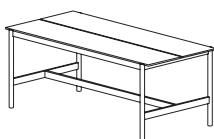

L 240 cm / 94.5"

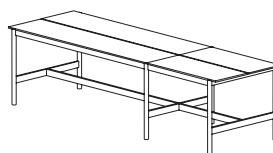

L 360 cm / 141.7"

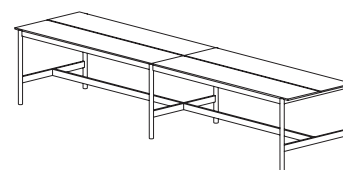

L 480 cm / 189"

#### Linear System Table High H105

Height — 105 cm / 41.4"  
Table top width — 110 cm / 43.3"  
Total width — 115 cm / 45.3"

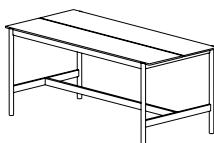

L 240 cm / 94.5"

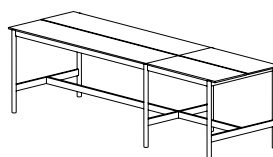

L 360 cm / 141.7"

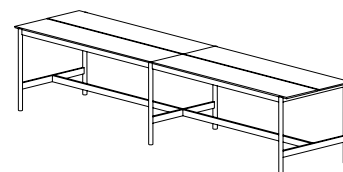

L 480 cm / 189"

### OPTION A

1. TABLES / 2. ACCESSORIES / 3. LIGHTING / 4. TABLE POWER OUTLET / 5. INTEGRATED POWER / 6. CABLE TRAY

# LINEAR SYSTEM SERIES—ORDER GUIDE

## STEP 2. ACCESSORIES

### Trays

Add your desired number of Linear System Trays.

#### Note

Trays must be mounted at least 5 cm / 2" from the table edge.

### Linear System Tray — Ø24 cm / 9.5"

Height — 15,6 cm / 6.2"  
Diameter — 24 cm / 9.5"



### Linear System Tray — Ø36 cm / 14.2"

Height — 9,6 cm / 3.8"  
Diameter — 36 cm / 14.2"



### Linear System Tray — 75 cm / 29.5"

Height — 15 cm / 5.9"  
Width — 21 cm / 8.3"  
Length — 75 cm / 29.5"

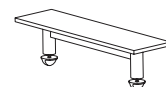

### Screens

Add your desired number of Linear System Screens.

#### Note

We recommend that screens are mounted to the table. They must be placed at least 5 cm / 2" from the table edge.

### Linear System Screen — 75 cm / 29.5"

Height — 35 cm / 13.8"  
Width — 15 cm / 5.9"  
Length — 75 cm / 29.5"

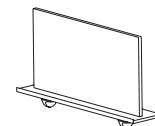

### Linear System Screen — 125 cm / 49.2"

Height — 35 cm / 13.8"  
Width — 15 cm / 5.9"  
Length — 125 cm / 49.2"

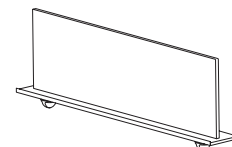

### Linear System Screen — 178 cm / 70.1"

Height — 35 cm / 13.8"  
Width — 15 cm / 5.9"  
Length — 178 cm / 70.1"

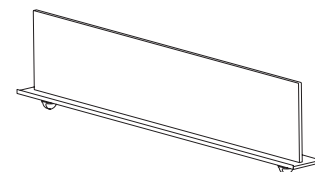

#### Note

Please note that only the Linear System Screen 125 cm / 49.2" can be mounted across the table.

### Example

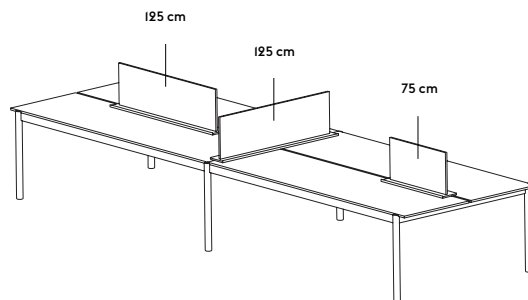

### OPTION A

1. TABLES / 2. ACCESSORIES / 3. LIGHTING / 4. TABLE POWER OUTLET / 5. INTEGRATED POWER / 6. CABLE TRAY

# LINEAR SYSTEM SERIES—ORDER GUIDE

## STEP 3. LIGHTING

Add your desired number of Linear Lamps.

**Note**  
The Linear Table Lamp has one USB-C plug.

### Linear Table Lamp

Height — 36,5 cm / 14.4"  
Width — 23,2 cm / 9.1"  
Depth — 16,5 cm / 6.5"



**Note**  
Linear Mounted Lamp must be mounted at least 5 cm / 2" from the table edge.

Please be aware that the Linear Mounted Lamp and Table Power Outlet, both designed for the Linear System Series, have a special power solution with special plugs. See more on page 4

### Linear Mounted Lamp — 23,2 cm / 9.1"

Height — 36,5 cm / 14.4"  
Width — 23,2 cm / 9.1"  
Depth — 10,7 cm / 4.2"

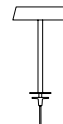

### Linear Mounted Lamp — 209,2 cm / 82.4"

Height — 70,7 cm / 27.8"  
Width — 209,2 cm / 82.4"  
Depth — 10,7 cm / 4.2"



### Linear Pendant Lamp — 87,2 cm / 34.3"

Height — 5,4 cm / 2.1"  
Width — 87,2 cm / 34.3"  
Depth — 10,7 cm / 4.2"



### Linear Pendant Lamp — 169,2 cm / 66.6"

Height — 5,4 cm / 2.1"  
Width — 169,2 cm / 66.6"  
Depth — 10,7 cm / 4.2"



## STEP 4. TABLE POWER OUTLETS

Specify your desired number of Table Power Outlets. Each Table Power Outlet has two outlets (one at each end) and one USB-A and USB-C plug to which standard plugs can be connected. Kindly remember to select your region-specific version.

**Note**  
Linear System Table Power Outlet must be mounted at least 5 cm / 2" from the table edge.

### Linear System Table Power Outlet — EU, UK

Height — 7 cm / 2.8"  
Width — 7 cm / 2.8"  
Length — 18 cm / 7.1"

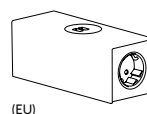

(EU)

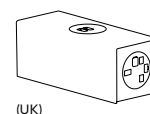

(UK)

### OPTION A

1. TABLES / 2. ACCESSORIES / 3. LIGHTING / 4. TABLE POWER OUTLET / 5. INTEGRATED POWER / 6. CABLE TRAY

# LINEAR SYSTEM SERIES—ORDER GUIDE

## STEP 5. INTEGRATED POWER FOR MOUNTED LAMPS & TABLE POWER OUTLETS

If you'd like to add the Mounted Lamp(s) or Table Power Outlet(s), select the Table Power Kit for the Linear System Table or one of the three Power Configurations that match your selected Linear System Table Configuration. Kindly remember to select the region-specific power kit.

**Note**  
Each Distribution Block has five outlets to which up to five Linear Mounted Lamps or Linear System Table Power Outlets can be plugged in.

The Extension Kit must be connected to the Power Kit. An Extension Kit has no standard plug.

Distribution Block — 5-way

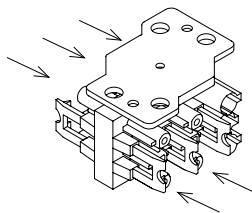

EU cable  
200 cm cable

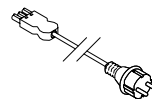

UK cable  
200 cm fused plug

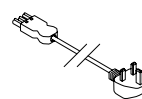

### Linear System Table

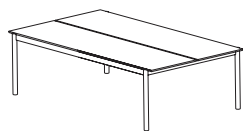

### Linear System Power

Power Kit (1 pcs)  
200 cm / 59" cable (EU or UK)  
Distribution Block

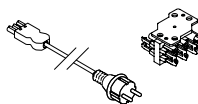

### Linear System Table Configuration 1

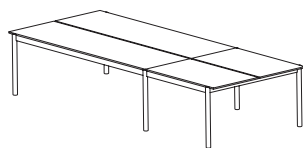

### Linear System Power Configuration 1

Power Kit (1 pcs)  
200 cm / 59" cable (EU or UK)  
Distribution Block

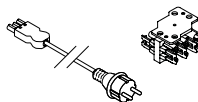

Power Extension Kit — 200 cm (1 pcs)  
200 cm / 79" cable  
Distribution Block

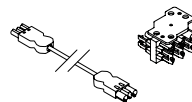

+

### Linear System Table Configuration 2

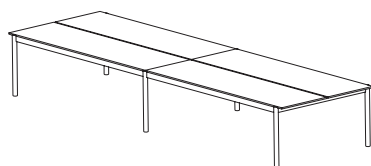

### Linear System Power Configuration 2

Power Kit (1 pcs)  
200 cm / 59" cable (EU or UK)  
Distribution Block

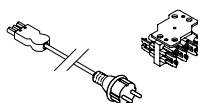

Power Extension Kit — 250 cm (1 pcs)  
250 cm / 98" cable  
Distribution Block

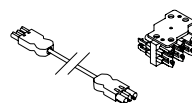

+

#### OPTION A

1. TABLES / 2. ACCESSORIES / 3. LIGHTING / 4. TABLE POWER OUTLET / 5. INTEGRATED POWER / 6. CABLE TRAY

PRICE LIST  
FOR MORE INFORMATION, VISIT MUUTO.COM

**MUUTO**



# LINEAR SYSTEM SERIES—ORDER GUIDE

**Note**  
The Integrated Power for Linear System Series has unique internal plugs to provide a slim and discreet look. This means that you cannot connect a standard plug to the power without using the Linear Table Power Outlet or changing the standard plug to a matching plug, being the Wieland GSTI8I3 plug.

The Linear Mounted Lamps must be connected to the integrated Power Kit.

Wieland GSTI8I3 plug

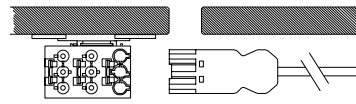

Standard plug (EU or UK)

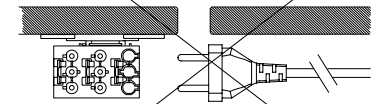

1. Connecting using the Wieland GSTI8I3 plug

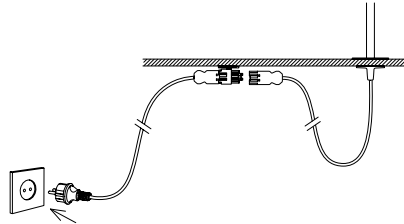

2. Connecting using a standard plug to the Linear Table Power Outlet

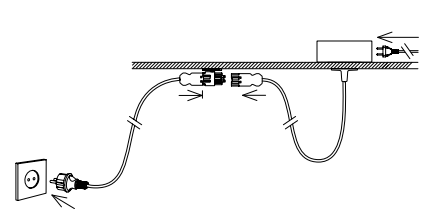

## LINEAR TABLE LAMP ONLY

The Linear Table Lamp can either be connected to a standard wall plug or the Table Power Outlet.

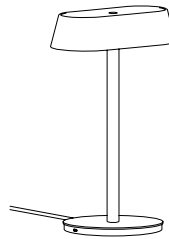

Standard plug

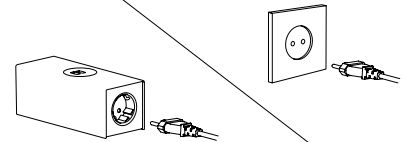

Linear Table Power Outlet

Alternatively, you can connect it to the integrated Power Kit by replacing the plug with a custom Wieland GSTI8I3 plug that is included with the lamp. Kindly refer to the Linear Table Lamp manual for instructions.

Integrated Power Kit (Wieland GSTI8I3 plug)

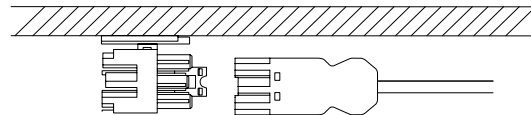

## OPTION A

1. TABLES / 2. ACCESSORIES / 3. LIGHTING / 4. TABLE POWER OUTLET / 5. INTEGRATED POWER / 6. CABLE TRAY

PRICE LIST  
FOR MORE INFORMATION, VISIT MUUTO.COM

**MUUTO**

# LINEAR SYSTEM SERIES—ORDER GUIDE

---

## STEP 6. CABLE TRAYS

We recommend using 1 Cable Tray for the End Module – 120 cm / 47.2" and up to 3 Cable Trays for the Linear Table, End Module – 240 cm / 94.2" and the Middle Module – 240 cm / 94.2".

### Linear System Cable Tray

Height – 3 cm / 1.2"  
Width – 22 cm / 8.7"  
Depth – 60 cm / 23.7"

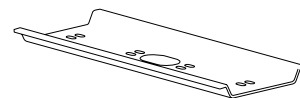

---

### Example:

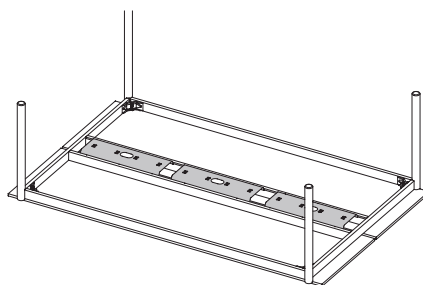

Linear System Table – 240 cm / 94.5"

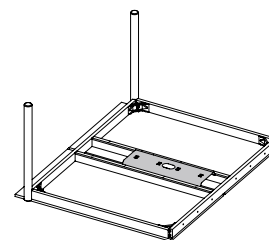

Linear System End Module – 120 cm / 47.2"

---

### OPTION A

1. TABLES / 2. ACCESSORIES / 3. LIGHTING / 4. TABLE POWER OUTLET / 5. INTEGRATED POWER / 6. CABLE TRAY

PRICE LIST  
FOR MORE INFORMATION, VISIT MUUTO.COM

**MUUTO**

# LINEAR SYSTEM SERIES—ORDER GUIDE

## Option B — Create your own configuration

### STEP 1. TABLES

#### A)

A configuration must always have End Modules in each end.

Start by defining the total length of your desired configuration, then select two table ends.

#### Note

Different finishes of tabletops cannot be mixed as they might vary in thickness.

#### Linear System End Module — 240 cm / 94.5"

Height — 74 cm / 29.1";  
Width — 146,9 cm / 57.8"  
Length — 240 cm / 94.5"  
No of Persons — 4-6



Height — 74 cm / 29.1";  
Width — 110 cm / 43.3";  
Length — 240 cm / 94.5"  
No of Persons — 4-6



Height - 95 cm / 37.4"  
Width - 110 cm / 43.3"  
Length - 240 cm / 94.5"  
No of Persons - 4-6

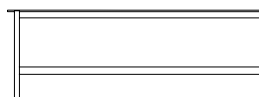

Height - 105 cm / 41.4"  
Width - 110 cm / 43.3"  
Length - 240 cm / 94.5"  
No of Persons - 4-6

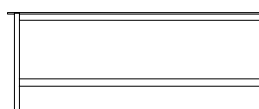

#### Linear System End Module — 120 cm / 47.2"

Height - 74 cm / 29.1"  
Width - 110 cm / 43.3"  
Length - 120 cm / 47.2"  
No of Persons - 2

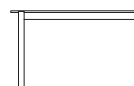

Height - 74 cm / 29.1"  
Width - 146,9 cm / 57.8"  
Length - 120 cm / 47.2"  
No of Persons - 2



Height - 95 cm / 37.4"  
Width - 110 cm / 43.3"  
Length - 120 cm / 47.2"  
No of Persons - 2

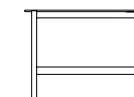

Height - 105 cm / 41.4"  
Width - 110 cm / 43.3"  
Length - 120 cm / 47.2"  
No of Persons - 2

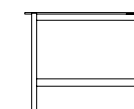

#### B)

Next, add the second, and final, End Module or your desired number of Middle Modules, only available in 240 cm / 94.5" length but in 2 different widths (110 cm / 43.3" and 142 cm / 55.9").

#### Note

Please note that it is not possible to connect more than two End Modules.

#### Linear System Middle Module — 240 cm / 94.5"

Width — 110 cm / 43.3";  
142 cm / 55.9"  
Length — 240 cm / 94.5"  
No of Persons — 4-6



#### C)

Next, you must order 1 set of Connecting Legs every time two modules are connected.

#### Note

95cm / 37.4" and 105cm / 41.4" Connecting Legs can only be connected to 110cm / 43.3" width tabletops (not to 142 cm/55.9" width tabletops).

#### Linear System Connecting Legs

Height — 74 cm / 29.1"  
95 cm / 37.4"  
105 cm / 41.4"

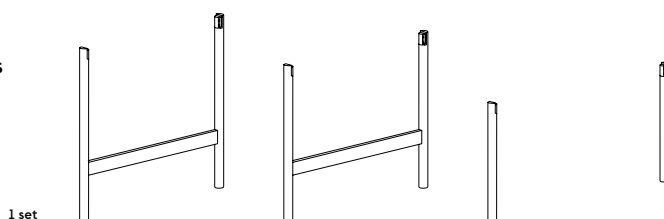

If you'd like a configuration of one End Module — 240 cm / 94.5" and one Middle Module — 240 cm / 94.5" and one End Module — 240 cm / 94.5", you must order two sets of Connecting Legs, as shown in the illustration.

#### Example

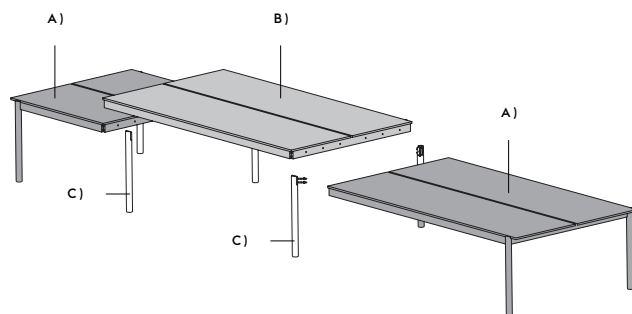

#### OPTION B

1. TABLES / 2. ACCESSORIES / 3. LIGHTING / 4. TABLE POWER OUTLET / 5. INTEGRATED POWER / 6. CABLE TRAY

# LINEAR SYSTEM SERIES—ORDER GUIDE

## STEP 2. ACCESSORIES

### Trays

Add your desired number of Linear System Trays.

#### Note

Trays must be mounted at least 5 cm / 2" from the table edge.

### Linear System Tray — Ø24 cm / 9.5"

Height — 15,6 cm / 6.2"  
Diameter — 24 cm / 9.5"



### Linear System Tray — Ø36 cm / 14.2"

Height — 9,6 cm / 3.8"  
Diameter — 36 cm / 14.2"



### Linear System Tray — 75 cm / 29.5"

Height — 15 cm / 5.9"  
Width — 21 cm / 8.3"  
Length — 75 cm / 29.5"

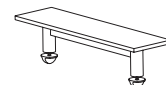

### Screens

Add your desired number of Linear System Screens.

#### Note

We recommend that screens are mounted to the table. They must be placed at least 5 cm / 2" from the table edge.

### Linear System Screen — 75 cm / 29.5"

Height — 35 cm / 13.8"  
Width — 15 cm / 5.9"  
Length — 75 cm / 29.5"

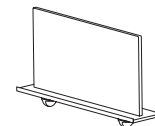

### Linear System Screen — 125 cm / 49.2"

Height — 35 cm / 13.8"  
Width — 15 cm / 5.9"  
Length — 125 cm / 49.2"

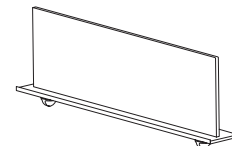

### Linear System Screen — 178 cm / 70.1"

Height — 35 cm / 13.8"  
Width — 15 cm / 5.9"  
Length — 178 cm / 70.1"

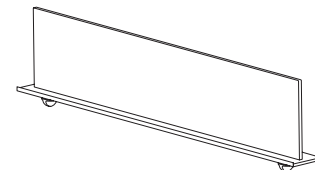

#### Note

Please note that only the Linear System Screen 125 cm / 49.2" can be mounted across the table.

### Example

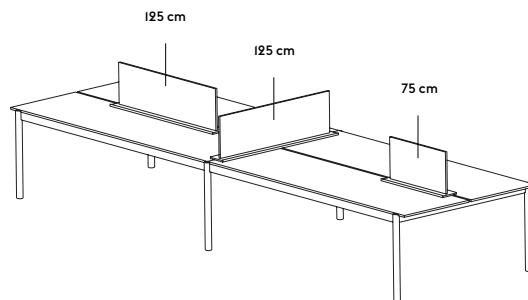

### OPTION B

1. TABLES / 2. ACCESSORIES / 3. LIGHTING / 4. TABLE POWER OUTLET / 5. INTEGRATED POWER / 6. CABLE TRAY

# LINEAR SYSTEM SERIES—ORDER GUIDE

## STEP 3. LIGHTING

Add your desired number of Linear Lamps.

**Note**  
The Linear Table Lamp has one USB-C plug.

### Linear Table Lamp

Height — 36,5 cm / 14.4"  
Width — 23,2 cm / 9.1"  
Depth — 16,5 cm / 6.5"



**Note**  
Linear Mounted Lamp must be mounted at least 5 cm / 2" from the table edge.

Please be aware that the Linear Mounted Lamp and Table Power Outlet, both designed for the Linear System Series, have a special power solution with special plugs. See more on page 4.

### Linear Mounted Lamp — 23,2 cm / 9.1"

Height — 36,5 cm / 14.4"  
Width — 23,2 cm / 9.1"  
Depth — 10,7 cm / 4.2"



### Linear Mounted Lamp — 209,2 cm / 82.4"

Height — 70,7 cm / 27.8"  
Width — 209,2 cm / 82.4"  
Depth — 10,7 cm / 4.2"



### Linear Pendant Lamp — 87,2 cm / 34.3"

Height — 5,4 cm / 2.1"  
Width — 87,2 cm / 34.3"  
Depth — 10,7 cm / 4.2"



### Linear Pendant Lamp — 169,2 cm / 66.6"

Height — 5,4 cm / 2.1"  
Width — 169,2 cm / 66.6"  
Depth — 10,7 cm / 4.2"



## STEP 4. TABLE POWER OUTLETS

Specify your desired number of Table Power Outlets. Each Table Power Outlet has two outlets (one at each end) and one USB-A and USB-C plug to which standard plugs can be connected. Kindly remember to select your region-specific version.

**Note**  
Linear System Table Power Outlet must be mounted at least 5 cm / 2" from the table edge.

### Linear System Table Power Outlet — EU, UK

Height — 7 cm / 2.8"  
Width — 7 cm / 2.8"  
Length — 18 cm / 7.1"

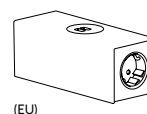

(EU)

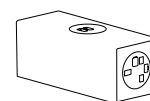

(UK)

## OPTION B

1. TABLES / 2. ACCESSORIES / 3. LIGHTING / 4. TABLE POWER OUTLET / 5. INTEGRATED POWER / 6. CABLE TRAY

PRICE LIST  
FOR MORE INFORMATION, VISIT MUUTO.COM

**MUUTO**

# LINEAR SYSTEM SERIES—ORDER GUIDE

## STEP 5. INTEGRATED POWER FOR MOUNTED LAMPS & TABLE POWER OUTLET

If you'd like to add the Mounted Lamp(s) and/or Table Power Outlet(s), select the Power Kit for the first End Module you choose and then add an a Power Extension Kit for each table added.

### Power Kit (1 pcs)

200 cm / 59" cable (EU or UK)  
Distribution Block

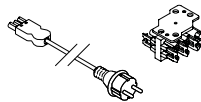

### Power Extension Kit (X pcs)

200 cm / 79" or 250 cm / 98" cable  
Distribution Block

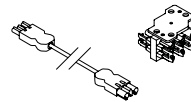

If you add a End Module or a Middle Module — 240 cm / 94.5", select the 250 cm / 98" Power Extension Kit.

If you add a End Module — 120 cm / 47.2", select the 200 cm / 79" Power Extension kit.

### Example 1

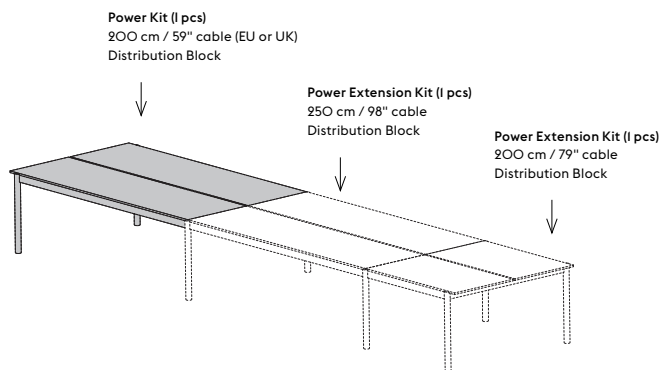

### Example 2

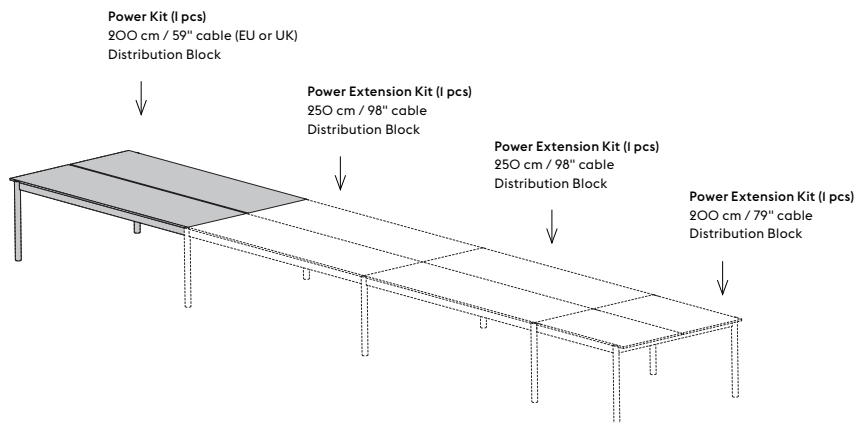

### OPTION B

1. TABLES / 2. ACCESSORIES / 3. LIGHTING / 4. TABLE POWER OUTLET / 5. INTEGRATED POWER / 6. CABLE TRAY

# LINEAR SYSTEM SERIES—ORDER GUIDE

## LINEAR TABLE LAMP ONLY

The Linear Table Lamp can either be connected to a standard wall plug or the Table Power Outlet.

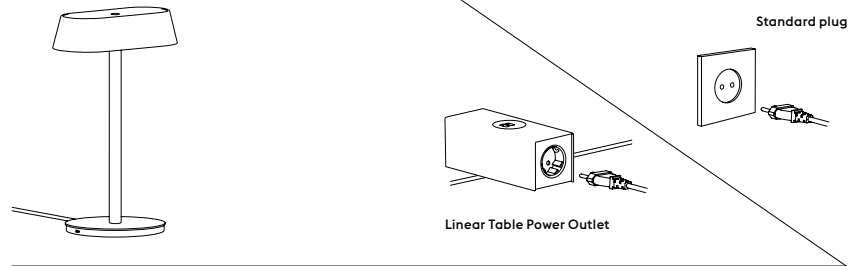

Alternatively, you can connect it to the integrated Table Power Kit by replacing the plug with a custom Wieland GST1813 plug that is included with the lamp. Kindly refer to the Linear Table Lamp manual for instructions.

Integrated Table Power Kit (Wieland GST1813 plug)

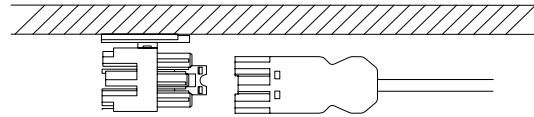

## STEP 6. CABLE TRAYS

We recommend using 1 Cable Tray for the End Module – 120 cm / 47.2" and up to 3 Cable Trays for the Linear Table, End Module – 240 cm / 94.2" and the Middle Module – 240 cm / 94.2".

### Linear System Cable Tray

Height – 3 cm / 1.2"  
Width – 22 cm / 8.7"  
Depth – 60 cm / 23.7"

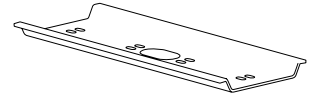

### Example:

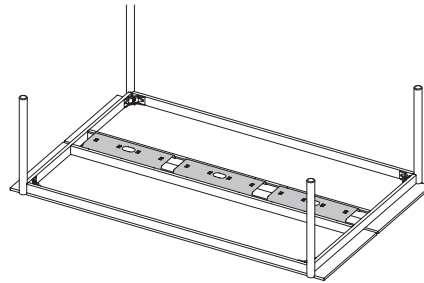

Linear System Table – 240 cm / 94.5"

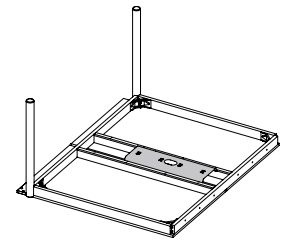

Linear System End Module – 120 cm / 47.2"

## OPTION B

1. TABLES / 2. ACCESSORIES / 3. LIGHTING / 4. TABLE POWER OUTLET / 5. INTEGRATED POWER / 6. CABLE TRAY

PRICE LIST  
FOR MORE INFORMATION, VISIT MUUTO.COM

**MUUTO**

